

RONDO

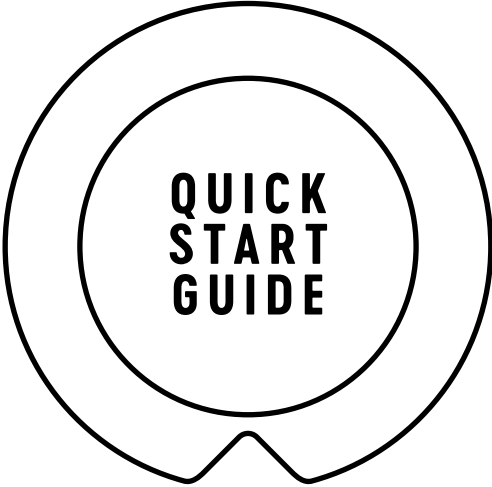

---

**LESS TALKING MORE RIDING**  
**LESS BULLSHIT MORE PERFORMANCE**  
**LESS POETRY MORE REALITY**  
**LESS EXCUSES MORE MOTIVATION**  
**LESS JARGON MORE JOY**



---

**THANK YOU!**

We just wanted to take a moment of your time to thank you for choosing us. There is a number of unique features in your bike, that makes it exceptionally good allrounder. We know not everyone is such a bike nerd to get deep into technical manual, so this guide is to help you quickly know what is what and why. Take a brief look inside and have fun riding your new bike. We're more than sure, that you will **love it!**

---

---

**SO, WHAT'S SPECIAL  
ABOUT YOUR BIKE?**

---

**rondo.cc**



**FLY CARBON** | Ultralight mix o high density carbon fibres and layup designed to provide desired flex and stiffness with no weight compromise. Rondo's recipe for flyweight setup.



**FLEX DESIGN** | Flex frames have been designed, shaped and layered, to give an extra bit of flex under the saddle. Special shape of seat stays and lowered seat post mounting point provides more vertical compliance to the rear triangle of the bike. Trust us - it really makes a difference. Bikes with FLEX DESIGN are REALLY comfortable.



**ROAD PLUS READY** | Enormous space for tires without compromise in geometry. With dropped chain stay and TwinTip fork, Rondo bikes are prepared to get plushy 650B road plus tires up to 47mm for maximum grip, control and comfort.



**HALO CLEARANCE** | Increased gravel bikes tire clearance up to 622-45 and 584-54. More grip, more control, more comfort.

check details on [rondo.cc](https://www.rondo.cc)

---

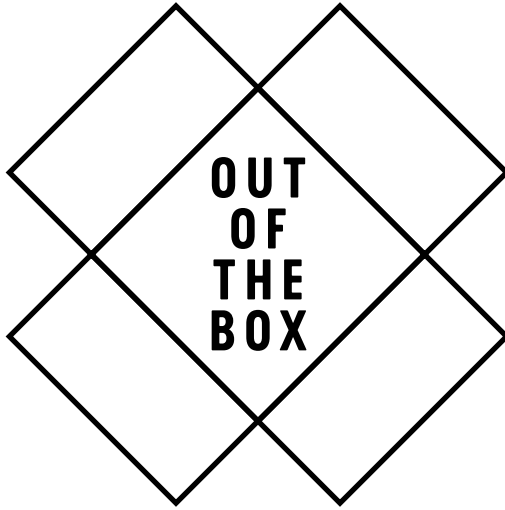

**OUT  
OF  
THE  
BOX**



---

BOLTS	TORQUE VALUE (Nm)
STEM BOLTS	5-6
SEAT BINDER BOLT	5-6
SEAT WEDGE BOLT	7-8
ROTOR BOLTS	6
PEDALS	35
THROUGH AXLE	10

If you purchased your bike from an online retailer, you will receive it in partly disassembled form. We try to make it easy for you, but you will still need to attach your own pedals, handlebar, seatpost, front rotor and front wheel. Please pay attention to correct torque values of different bolts on your bike.

If you don't have proper tools or feel unsure how to do it - just leave it to your local bike shop, it's always good to support them.



# VARIO GEO

Thanks to the TWINTIP fork you can change your position and adjust the steering character

of the bike. The first setting, with steeper angles, smaller trail and a lower riding position will be the choice for racing and dynamic, sporty riding on smooth roads. The alternative fork setting gives the bike slacker angles, longer trail and a bit more relaxed riding position, perfect for long distance adventure riding and endurance training. It also gives the rider a lot of confidence in challenging offroad terrain, especially on fast, steep downhills.

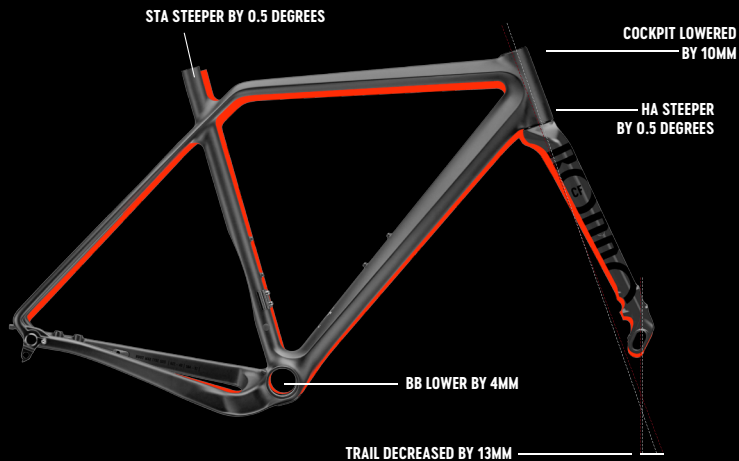

| RUUT SERIES |

## HOW IT WORKS?\*

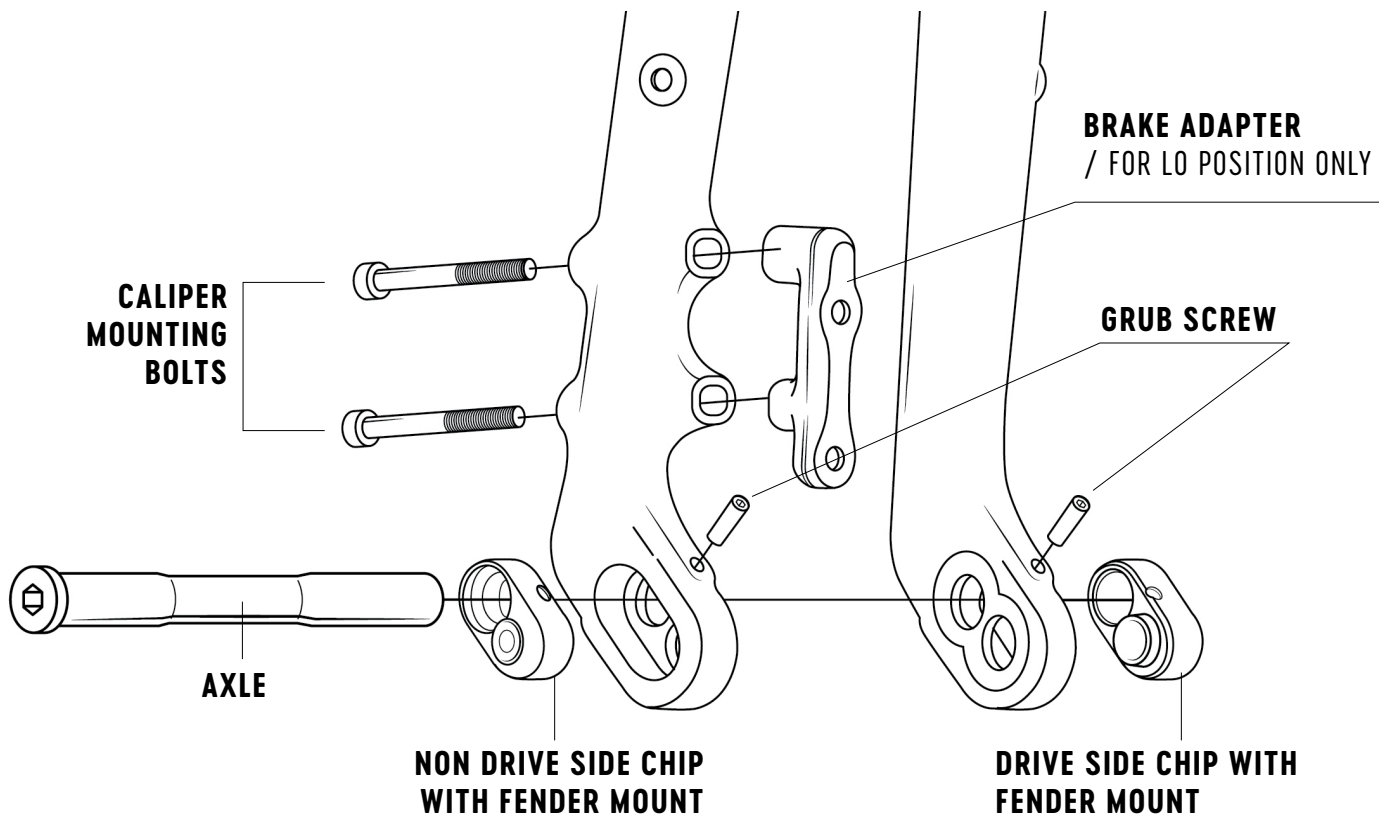

\* the figure shows Ruut fork but the principle is the same in all models. Please refer to the manual and resources on our website for more detailed information.

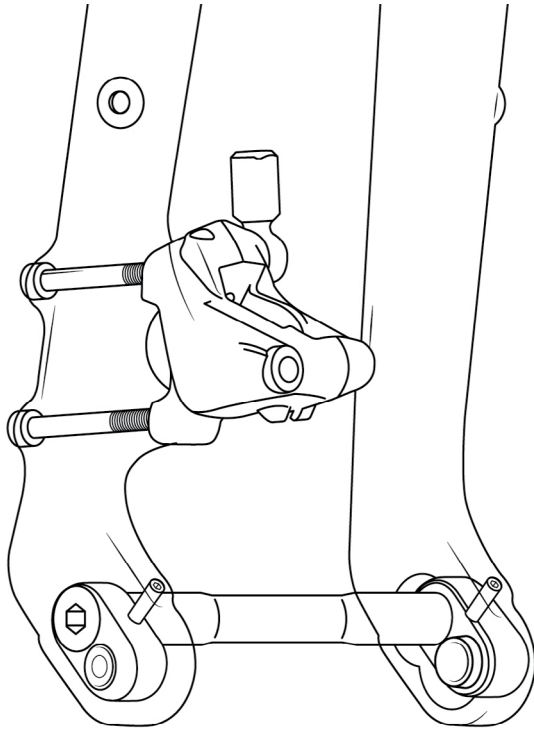

**HI POSITION**

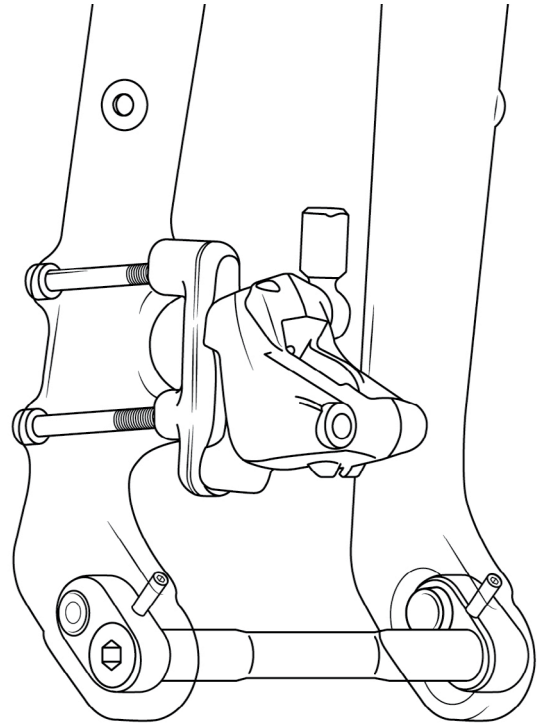

**LO POSITION**

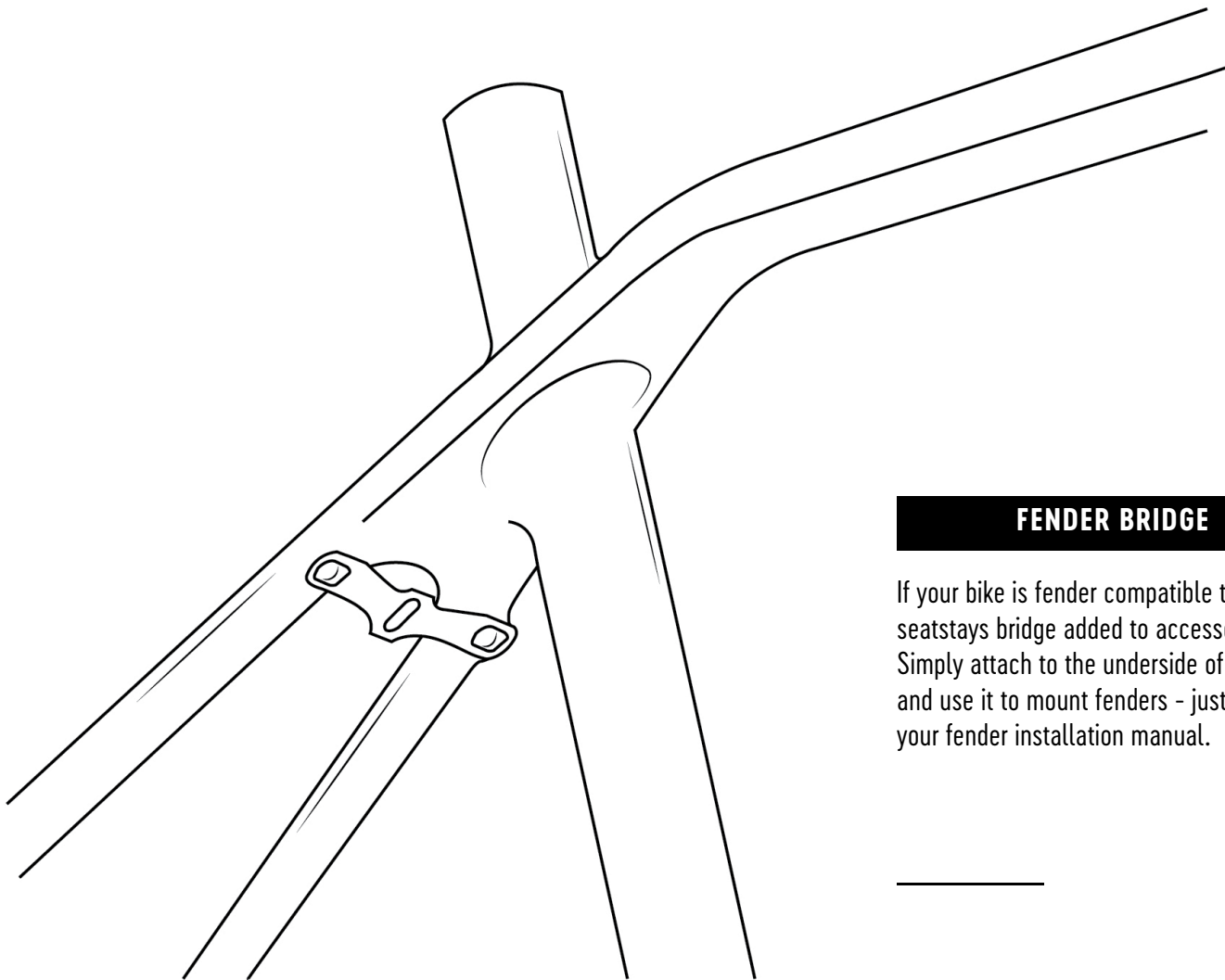

## FENDER BRIDGE

If your bike is fender compatible there is seatstays bridge added to accessories. Simply attach to the underside of seatstays and use it to mount fenders - just follow your fender installation manual.

---

## PROTECTIVE TAPE

We include a sheet of hard wearing protective stickers with every bike. Apply to your frame at critical areas, points where cables touch the frame, on the chainstay to protect from chain marks, under the down tube to save the paint from dings etc. Before applying, make sure the surface is clean and degreased.

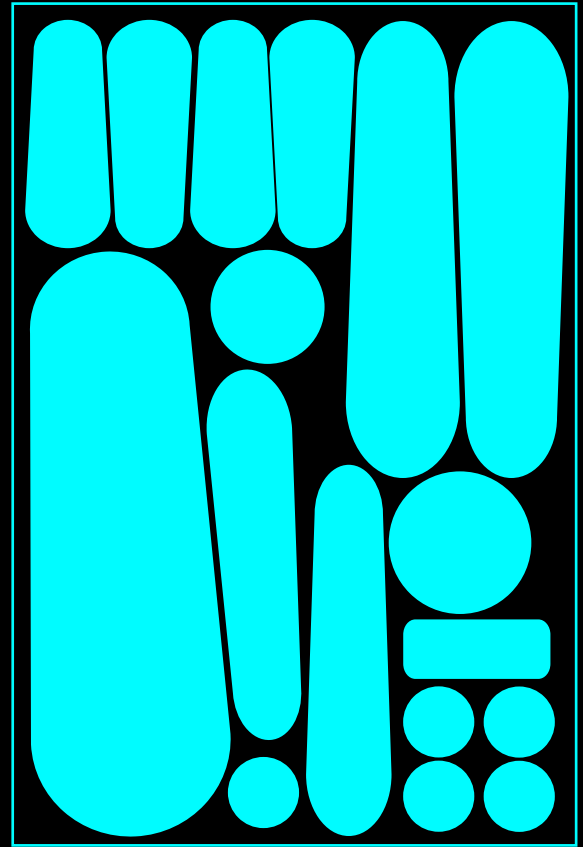
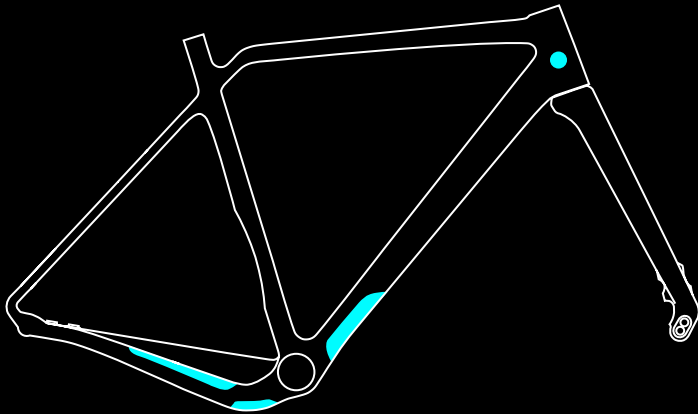

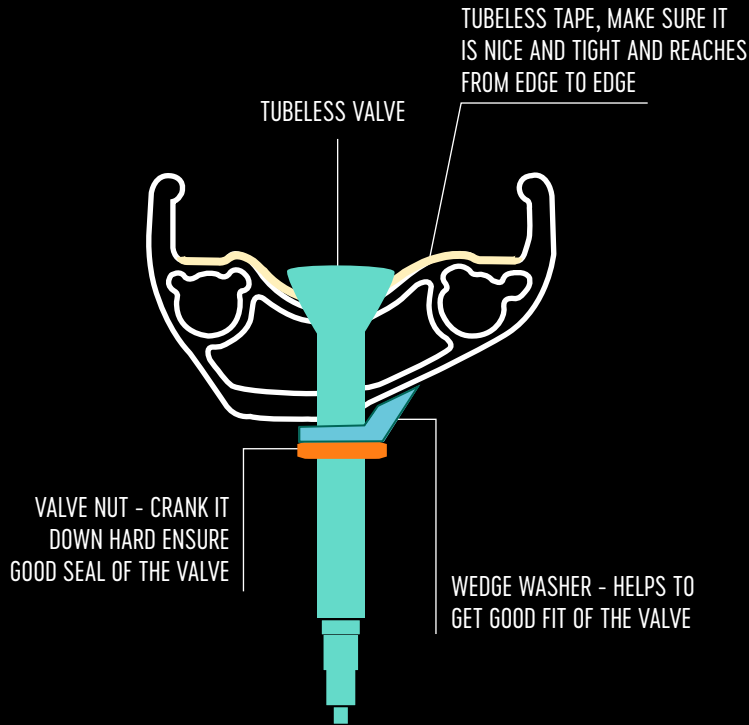

All our rims are tubeless ready. So are the tyres on most models [except Ruut AL2 and ST2].

To convert you need to add tubeless tape, valve and sealant [none included with the bike purchase].

Make sure the tape covers the entire width of the rim from hook to hook. If your tape is narrower than the internal width of the rim – just do two overlapping runs, each aligned closely with the rim hook. We found that a valve with conical shaped rubber grommet is most secure on our rims. To make it easier to tighten the valve down on asymmetrical rim, it may be good idea to use wedge-shaped spacer between the rim and the valve lock nut. All available from good bike stores.

Once you have your rims prepared just follow the steps of your tubeless sealant maker to set your tires without tubes.

---

---

## RIGHT TYRE PRESSURE

Riding with the right tyre pressure is key to smooth, comfortable and efficient ride. The correct tyre pressure for you will depend on your weight, tyre size and road surface. It is best to experiment to get the best from your bike. You may find the the pressure which gives you the right balance of speed and comfort is likely much lower than you thought. Below is a simple cheat sheet for tubeless tyres to get you started, use it as a starting point and adjust depending on your needs (higher if you weigh more or ride aggressively, lower if you are lighter and shred lightly).

RIDER	TYRE WIDTH		
WEIGHT	25-28MM	38-43MM	45-47MM
60 KG	63PSI / 4.4BAR	29PSI / 1.9BAR	24PSI / 1.7BAR
70 KG	75PSI / 5.2BAR	33PSI / 2.2BAR	29PS / 1.9BAR
80 KG	82PSI / 5.7BAR	36PSI / 2.5BAR	31PSI / 2.1BAR
90 KG	91PSI / 6.2BAR	39PSI / 2.7BAR	34PSI / 2.4BAR

---

NOW, THAT YOU HAVE LEARNED ABOUT RONDO BIKE YOU ARE ALMOST READY TO GO FOR A RIDE.  
BUT BEFORE YOU DO...

## **GREASE YOUR SEATPOST NOW!**

IF YOUR BIKE USES CARBON FIBER SEATPOST, USE SUPPLIED CARBON ASSEMBLY PASTE

- THIS WILL PREVENT SLIPPING WITHOUT USING EXCESSIVE TORQUE ON SEAT CLAMP.

IF YOUR BIKE COMES WITH ALUMINIUM SEAT POST, JUST USE ANY GOOD QUALITY GREASE OR ANTI-SEIZE COMPOUND

- THIS WILL INHIBIT CORROSION AND STOP THE SEATPOST FROM SEIZING INSIDE THE FRAME.

YOU WILL THANK US LATER. GO!

# **RONDO**